

INSTRUCTIONS FOR USE

AMJEVITA™ (am-jeh-vee'-tah)

(adalimumab-atto)

10 mg/0.2 mL

injection, for subcutaneous use

single-dose prefilled syringe

This Instructions for Use contains information on how to inject AMJEVITA with a prefilled syringe.

If your healthcare provider decides that a caregiver may be able to give your injections of AMJEVITA at home, they should receive training on the right way to prepare and inject AMJEVITA. Do not try to inject until they have been shown the right way to give the injections by your healthcare provider or nurse.

The medicine in the AMJEVITA prefilled syringe is for injection under the skin (subcutaneous injection). See the AMJEVITA Medication Guide for information about AMJEVITA.

Getting to know your prefilled syringe

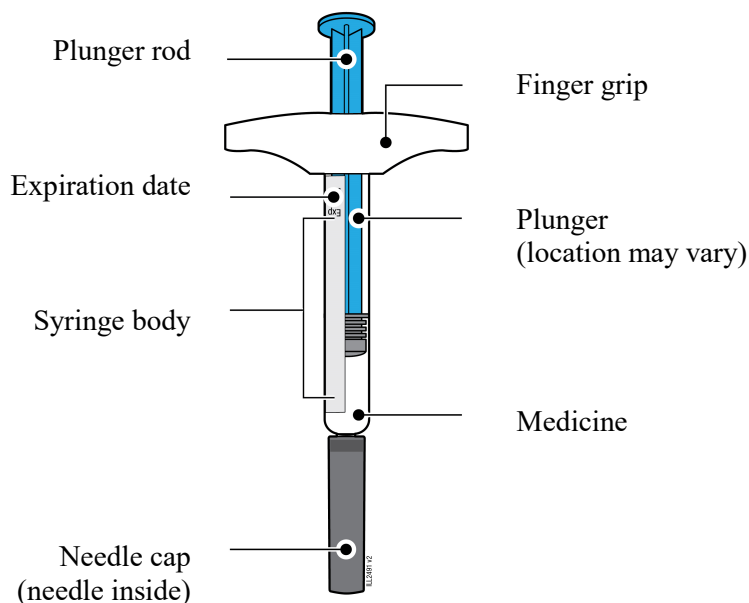

1. Important Information You Need to Know Before Injecting AMJEVITA

- It is important that you do not try to give the injection until you have fully read and understood this Instructions for Use.
- **Do not** use the syringe if the carton is damaged or the seal is broken.
- **Do not** use the syringe after the expiration date on the label.
- **Do not** shake the syringe.
- **Do not** remove the needle cap from the syringe until you are ready to inject.
- **Do not** use the syringe if it has been frozen.
- **Do not** use the syringe if it has been dropped on a hard surface. Part of the syringe may be broken even if you cannot see the break. Use a new syringe, and call 1-800-77-AMGEN (1-800-772-6436).
- The syringe is not made with natural rubber latex.

Important: Keep the syringe and sharps disposal container out of the sight and reach of children.

Frequently asked questions:

For additional information and answers to frequently asked questions, visit www.amjevita.com.

Where to get help:

If you want more information or help using AMJEVITA:

- Contact your healthcare provider,
- Visit www.amjevita.com, or
- Call 1-800-77-AMGEN (1-800-772-6436)

2. Storing and Preparing to Inject AMJEVITA



Refrigerate in carton until ready to use

2a Refrigerate the syringe carton until you are ready to use it.

- Keep the syringe in the refrigerator between 36°F to 46°F (2°C to 8°C).
- Keep the syringe in the original carton to protect it from light or physical damage.
- **Do not** freeze the syringe.
- **Do not** store the syringe in extreme heat or cold. For example, avoid storing in your vehicle's glove box or trunk.

Important: Keep the syringe out of the sight and reach of children.

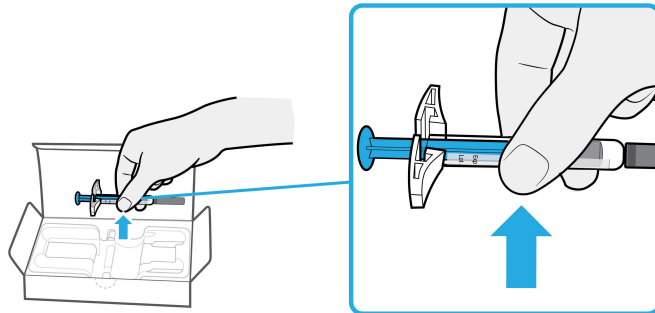

2b Grasp the syringe by the body and remove it from the carton.

- **Do not** grab the finger grip, plunger rod, or the needle cap.
- Remove the number of syringes you need for your injection.
- Put any unused syringes back into the refrigerator.

Wait



2c Wait 15 to 30 minutes for the syringe to reach room temperature.

- Let the syringe warm up naturally.
- **Do not** heat the syringe with hot water, a microwave or direct sunlight.
- **Do not** shake the syringe at any time.
- Using the syringe at room temperature allows for a more comfortable injection.



2d You may keep AMJEVITA at room temperature for up to 14 days, if needed.

- For example when you are traveling, you may keep AMJEVITA at room temperature.
 - Keep it at room temperature between 68° F to 77° F (20° C to 25° C).
 - **Do not** put it back in the refrigerator.
 - Record the date you removed it from the refrigerator and use it within **14** days.

Important: Place the syringe in a sharps disposal container if it has reached room temperature and has not been used within **14** days.

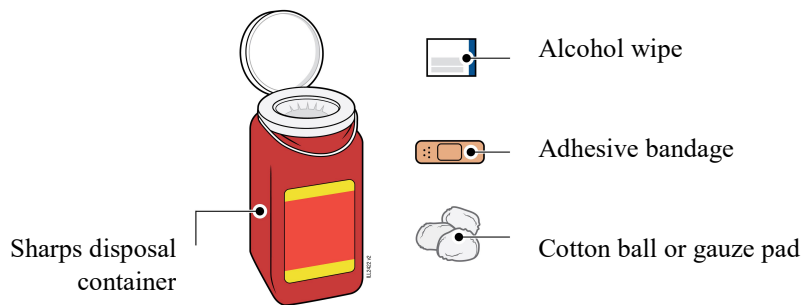

2e Gather and place the following items for your injection on a clean, flat, and well-lit surface:

- AMJEVITA syringe (room temperature)
- Sharps disposal container [see Disposing of AMJEVITA and Checking the Injection Site]
- Alcohol wipe
- Adhesive bandage
- Cotton ball or gauze pad

3. Getting Ready for Your Injection

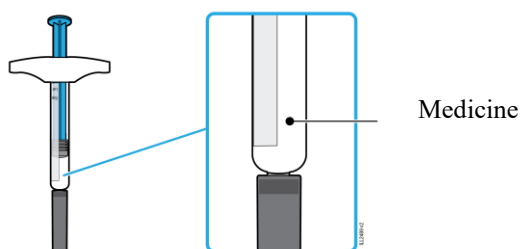

3a Inspect the medicine. It should be clear and colorless to pale yellow.

- It is okay to see air bubbles in the syringe.
- **Do not** use AMJEVITA if the medicine is cloudy, discolored or has flakes.

Important: If the medicine is cloudy, discolored or has flakes or if the syringe is damaged or expired, call 1-800-77-AMGEN (1-800-722-6436).

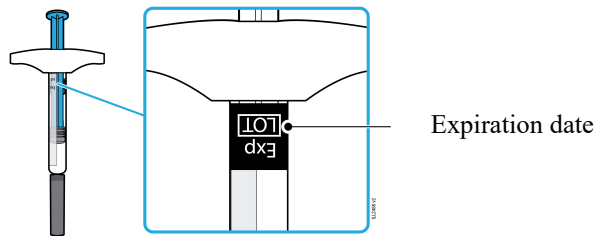

3b Check the expiration date (Exp.) and inspect the syringe for damage.

- **Do not** use the syringe if the expiration date has passed.
- **Do not** use the syringe if:
 - the needle cap is missing or loose.
 - it has cracks or broken parts.
 - it has been dropped on a hard surface.
- Make sure you have the right medicine and dose.

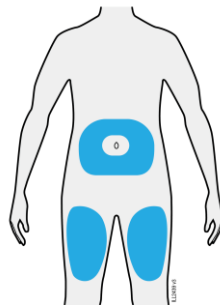

3c Inject into 1 of these locations.

- Inject into the front of your thigh or stomach (except for 2 inches around your belly button).
- Choose a different site for each injection.

Important: Avoid areas with scars, stretch marks or where the skin is tender, bruised, red or hard.



3d Wash hands thoroughly with soap and water.

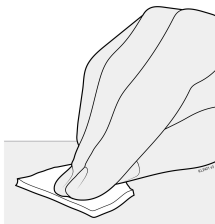

3e Clean the injection site with an alcohol wipe.

- Let the skin dry on its own.
- **Do not** touch this area again before injecting.

4. Injecting AMJEVITA

Important: Only remove the needle cap when you can inject right away (within 5 minutes) because the medicine can dry out.

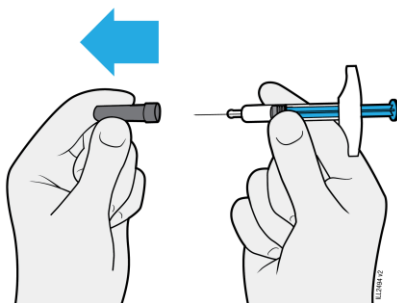

4a Pull the needle cap straight off while holding the syringe body.

- **Do not** twist or bend the needle cap.
- **Never** put the needle cap back on. It may damage the needle.
- **Do not** let anything touch the needle after you remove the needle cap.
- **Do not** place the uncapped syringe on any surface after you remove the needle cap.
- **Do not** try to push air bubbles out of the syringe. It is okay to see air bubbles.
- It is normal to see a drop of medicine come out of the needle.

Important: Never put the needle cap back on to avoid accidental needlestick injury.



4b Place the needle cap in the sharps disposal container.

PINCH

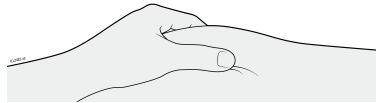

4c Pinch the skin around the injection site before injection.

- Pinch the skin between the thumb and pointer (index) finger to create a bump for injection.
- If possible, the bump should be about 2 inches wide.

Important: Continue to pinch the skin until the injection is complete.

INSERT

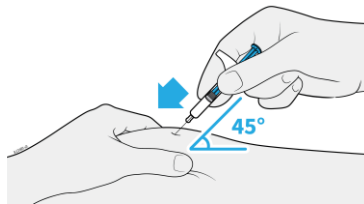

4d Insert the needle into the pinched skin at about a 45-degree angle.

- **Do not** place your finger on the plunger rod while inserting the needle, as this may result in lost medicine.

INJECT

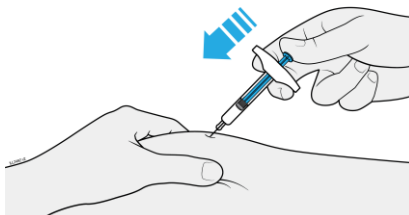

4e Slowly press the plunger rod all the way down until it reaches the bottom to inject the medicine.

- **Do not** pull back on the plunger rod at any time.
- **Do not** remove the syringe until all of the medicine has been injected.

5. Disposing of AMJEVITA and Checking the Injection Site

Important: Never put the needle cap back on.

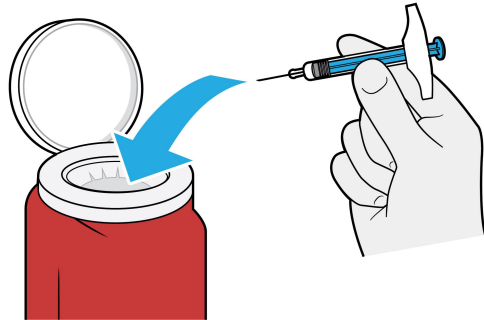

5a Place the used syringe in an FDA-cleared sharps disposal container right away after use.

Important: Do not throw away the syringe in your household trash.

- **Do not** reuse the syringe.

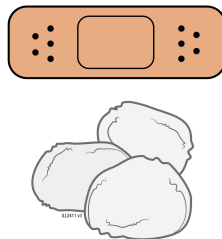

5b Check the injection site.

- **Do not** rub the injection site.
- If there is blood, press a cotton ball or gauze pad on the injection site. Apply an adhesive bandage if necessary.

Additional information about your sharps disposal container

If you do not have an FDA-cleared sharps disposal container you may use a household container that is:

- made of a heavy-duty plastic,
- can be closed with a tight-fitting, puncture-resistant lid, without sharps being able to come out,
- upright and stable during use,
- leak-resistant, and
- properly labeled to warn of hazardous waste inside the container.

Disposing of sharps containers:

When your sharps disposal container is almost full, you will need to follow your community guidelines for the right way to dispose of your sharps disposal container.

There may be state or local laws about how you should throw away used needles and syringes.

For more information about safe sharps disposal, and for specific information about sharps disposal in the state that you live in, go to the FDA's website at: <http://www.fda.gov/safesharpsdisposal>

Do not dispose of your used sharps disposal container in your household trash unless your community guidelines permit this.

Do not recycle your used sharps disposal container.

For more information or help call 1-800-77-AMGEN (1-800-772-6436).

This Instructions for Use has been approved by the US Food and Drug Administration.

AMJEVITA (adalimumab-atto)

AMGEN[®]

Manufactured by:

Amgen Inc.

One Amgen Center Drive

Thousand Oaks, California 91320-1799

US License Number 1080

©2023 Amgen Inc. All rights reserved.

nnnnnnnnnn

Issued: 04/2023